

## FEATURES

- **Wide Input Voltage Range: 4V to 80V**
- **Low Quiescent Current: 40µA**
- **Low Dropout Voltage: 400mV**
- **Output Current: 250mA**
- No Protection Diodes Needed
- Adjustable Output from 1.24V to 60V
- 1µA Quiescent Current in Shutdown
- Stable with 3.3µF Output Capacitor
- Stable with Aluminum, Tantalum or Ceramic Capacitors
- Reverse-Battery Protection
- No Reverse Current Flow from Output to Input
- Thermal Limiting
- Thermally Enhanced 16-Lead TSSOP and 12-Pin (4mm × 3mm) DFN Packages

## APPLICATIONS

- Low Current High Voltage Regulators
- Regulator for Battery-Powered Systems
- Telecom Applications
- Automotive Applications

## DESCRIPTION

The LT<sup>®</sup>3012 is a high voltage, micropower low dropout linear regulator. The device is capable of supplying 250mA of output current with a dropout voltage of 400mV. Designed for use in battery-powered or high voltage systems, the low quiescent current (40µA operating and 1µA in shutdown) makes the LT3012 an ideal choice. Quiescent current is also well controlled in dropout.

Other features of the LT3012 include the ability to operate with very small output capacitors. The regulator is stable with only 3.3µF on the output while most older devices require between 10µF and 100µF for stability. Small ceramic capacitors can be used without any need for series resistance (ESR) as is common with other regulators. Internal protection circuitry includes reverse-battery protection, current limiting, thermal limiting and reverse current protection.

The device is available with an adjustable output with a 1.24V reference voltage. The LT3012 regulator is available in the 16-lead TSSOP and 12 pin low profile (0.75mm) (4mm × 3mm) DFN packages with an exposed pad for enhanced thermal handling capability.

LT, LT, LTC and LTM are registered trademarks of Linear Technology Corporation. All other trademarks are the property of their respective owners.

## TYPICAL APPLICATION

5V Supply with Shutdown

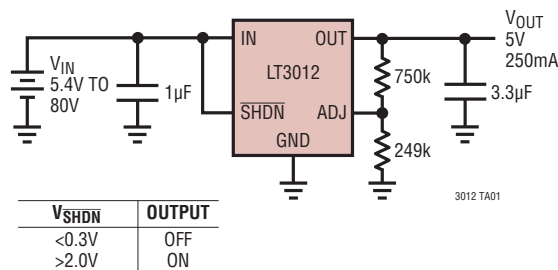

Dropout Voltage

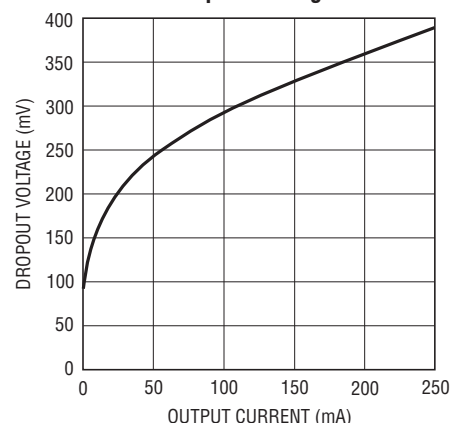

# LT3012

## ABSOLUTE MAXIMUM RATINGS (Note 1)

IN Pin Voltage .....	±80V	Storage Temperature Range	
OUT Pin Voltage .....	±60V	TSSOP Package .....	-65°C to 150°C
IN to OUT Differential Voltage .....	±80V	DFN Package .....	-65°C to 125°C
ADJ Pin Voltage .....	±7V	Operating Junction Temperature Range	
SHDN Pin Input Voltage .....	±80V	(Notes 3, 10, 11)	
Output Short-Circuit Duration .....	Indefinite	LT3012E .....	-40°C to 125°C
		LT3012HFE .....	-40°C to 140°C
		Lead Temperature (FE16 Soldering, 10 sec) .....	300°C

## PIN CONFIGURATION

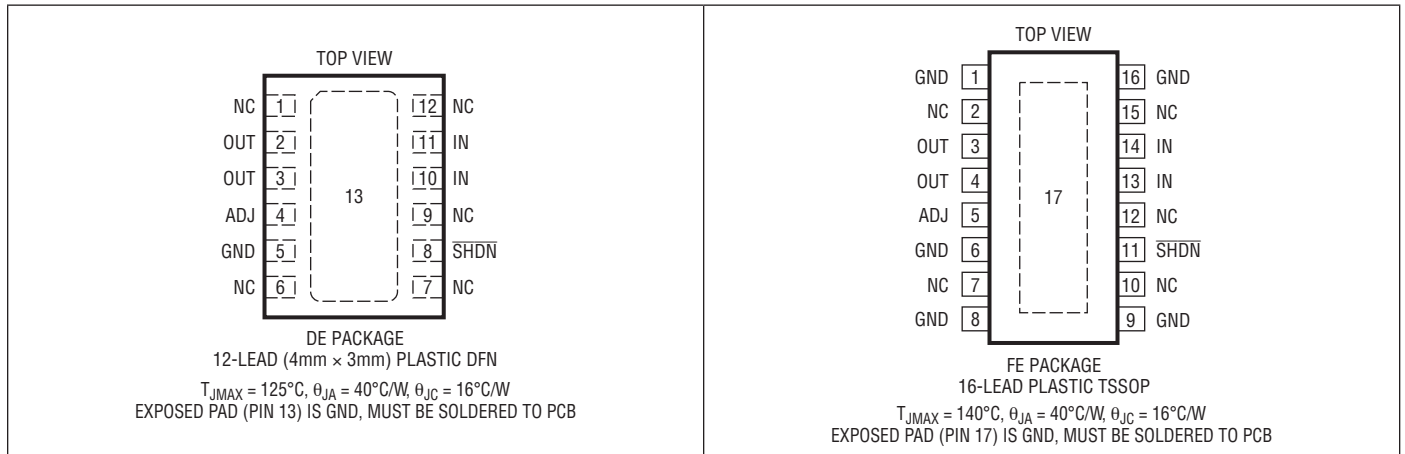

## ORDER INFORMATION

LEAD FREE FINISH	TAPE AND REEL	PART MARKING	PACKAGE DESCRIPTION	TEMPERATURE RANGE
LT3012EDE#PBF	LT3012EDE#TRPBF	3012	12-Lead (4mm × 3mm) Plastic DFN	-40°C to 125°C
LT3012EFE#PBF	LT3012EFE#TRPBF	3012EFE	16-Lead Plastic TSSOP	-40°C to 125°C
LT3012HFE#PBF	LT3012HFE#TRPBF	3012HFE	16-Lead Plastic TSSOP	-40°C to 140°C
LEAD BASED FINISH	TAPE AND REEL	PART MARKING	PACKAGE DESCRIPTION	TEMPERATURE RANGE
LT3012EDE	LT3012EDE#TR	3012	12-Lead (4mm × 3mm) Plastic DFN	-40°C to 125°C
LT3012EFE	LT3012EFE#TR	3012EFE	16-Lead Plastic TSSOP	-40°C to 125°C
LT3012HFE	LT3012HFE#TR	3012HFE	16-Lead Plastic TSSOP	-40°C to 140°C

Consult LTC Marketing for parts specified with wider operating temperature ranges.

For more information on lead free part marking, go to: <http://www.linear.com/leadfree/>

For more information on tape and reel specifications, go to: <http://www.linear.com/tapeandreel/>

## ELECTRICAL CHARACTERISTICS (LT3012E)

The ● denotes the specifications which apply over the -40°C to 125°C operating temperature range, otherwise specifications are at T<sub>J</sub> = 25°C.

PARAMETER	CONDITIONS	MIN	TYP	MAX	UNITS
Minimum Input Voltage	I <sub>LOAD</sub> = 250mA ●		4	4.75	V
ADJ Pin Voltage (Notes 2, 3)	V <sub>IN</sub> = 4V, I <sub>LOAD</sub> = 1mA ●	1.225	1.24	1.255	V
	4.75V < V <sub>IN</sub> < 80V, 1mA < I <sub>LOAD</sub> < 250mA ●	1.2	1.24	1.28	V
Line Regulation	ΔV <sub>IN</sub> = 4V to 80V, I <sub>LOAD</sub> = 1mA (Note 2) ●		0.1	5	mV
Load Regulation (Note 2)	V <sub>IN</sub> = 4.75V, ΔI <sub>LOAD</sub> = 1mA to 250mA ●		7	12	mV
	V <sub>IN</sub> = 4.75V, ΔI <sub>LOAD</sub> = 1mA to 250mA ●			25	mV
Dropout Voltage V <sub>IN</sub> = V <sub>OUT(NOMINAL)</sub> (Notes 4, 5)	I <sub>LOAD</sub> = 10mA ●		160	230	mV
	I <sub>LOAD</sub> = 10mA ●			300	mV
	I <sub>LOAD</sub> = 50mA ●		250	340	mV
	I <sub>LOAD</sub> = 50mA ●			420	mV
	I <sub>LOAD</sub> = 250mA ●		400	490	mV
	I <sub>LOAD</sub> = 250mA ●			620	mV
GND Pin Current V <sub>IN</sub> = 4.75V (Notes 4, 6)	I <sub>LOAD</sub> = 0mA ●		40	100	μA
	I <sub>LOAD</sub> = 100mA ●		3		mA
	I <sub>LOAD</sub> = 250mA ●		10	18	mA
Output Voltage Noise	C <sub>OUT</sub> = 10μF, I <sub>LOAD</sub> = 250mA, BW = 10Hz to 100kHz		100		μV <sub>RMS</sub>
ADJ Pin Bias Current	(Note 7)		30	100	nA
Shutdown Threshold	V <sub>OUT</sub> = Off to On ●		1.3	2	V
	V <sub>OUT</sub> = On to Off ●	0.3	0.8		V
SHDN Pin Current (Note 8)	V <sub>SHDN</sub> = 0V		0.3	2	μA
	V <sub>SHDN</sub> = 6V		0.1	1	μA
Quiescent Current in Shutdown	V <sub>IN</sub> = 6V, V <sub>SHDN</sub> = 0V		1	5	μA
Ripple Rejection	V <sub>IN</sub> = 7V(Avg), V <sub>RIPPLE</sub> = 0.5V <sub>P-P</sub> , f <sub>RIPPLE</sub> = 120Hz, I <sub>LOAD</sub> = 250mA	65	75		dB
Current Limit	V <sub>IN</sub> = 7V, V <sub>OUT</sub> = 0V ●		400		mA
	V <sub>IN</sub> = 4.75V, ΔV <sub>OUT</sub> = -0.1V (Note 2) ●	250			mA
Reverse Output Current (Note 9)	V <sub>OUT</sub> = 1.24V, V <sub>IN</sub> < 1.24V (Note 2)		12	25	μA

## ELECTRICAL CHARACTERISTICS (LT3012H)

The ● denotes the specifications which apply over the -40°C to 140°C operating temperature range, otherwise specifications are at T<sub>J</sub> = 25°C.

PARAMETER	CONDITIONS	MIN	TYP	MAX	UNITS
Minimum Input Voltage	I <sub>LOAD</sub> = 200mA ●		4	4.75	V
ADJ Pin Voltage (Notes 2, 3)	V <sub>IN</sub> = 4V, I <sub>LOAD</sub> = 1mA ●	1.225	1.24	1.255	V
	4.75V < V <sub>IN</sub> < 80V, 1mA < I <sub>LOAD</sub> < 200mA ●	1.2	1.24	1.28	V
Line Regulation	ΔV <sub>IN</sub> = 4V to 80V, I <sub>LOAD</sub> = 1mA (Note 2) ●		0.1	5	mV
Load Regulation (Note 2)	V <sub>IN</sub> = 4.75V, ΔI <sub>LOAD</sub> = 1mA to 200mA ●		6	12	mV
	V <sub>IN</sub> = 4.75V, ΔI <sub>LOAD</sub> = 1mA to 200mA ●			30	mV
Dropout Voltage V <sub>IN</sub> = V <sub>OUT(NOMINAL)</sub> (Notes 4, 5)	I <sub>LOAD</sub> = 10mA ●		160	230	mV
	I <sub>LOAD</sub> = 10mA ●			320	mV
	I <sub>LOAD</sub> = 50mA ●		250	340	mV
	I <sub>LOAD</sub> = 50mA ●			450	mV
	I <sub>LOAD</sub> = 200mA ●		360	490	mV
	I <sub>LOAD</sub> = 200mA ●			630	mV
GND Pin Current V <sub>IN</sub> = 4.75V (Notes 4, 6)	I <sub>LOAD</sub> = 0mA ●		40	110	μA
	I <sub>LOAD</sub> = 100mA ●		3		mA
	I <sub>LOAD</sub> = 200mA ●		7	18	mA

## ELECTRICAL CHARACTERISTICS (LT3012H)

The ● denotes the specifications which apply over the  $-40^{\circ}\text{C}$  to  $140^{\circ}\text{C}$  operating temperature range, otherwise specifications are at  $T_J = 25^{\circ}\text{C}$ .

PARAMETER	CONDITIONS	MIN	TYP	MAX	UNITS
Output Voltage Noise	$C_{OUT} = 10\mu\text{F}$ , $I_{LOAD} = 200\text{mA}$ , $\text{BW} = 10\text{Hz to } 100\text{kHz}$		100		$\mu\text{V}_{\text{RMS}}$
ADJ Pin Bias Current	(Note 7)		30	100	nA
Shutdown Threshold	$V_{OUT} = \text{Off to On}$ $V_{OUT} = \text{On to Off}$	● ●	1.3 0.8	2	V V
$\overline{\text{SHDN}}$ Pin Current (Note 8)	$V_{\overline{\text{SHDN}}} = 0\text{V}$ $V_{\overline{\text{SHDN}}} = 6\text{V}$		0.3 0.1	2 1	$\mu\text{A}$ $\mu\text{A}$
Quiescent Current in Shutdown	$V_{IN} = 6\text{V}$ , $V_{\overline{\text{SHDN}}} = 0\text{V}$		1	5	$\mu\text{A}$
Ripple Rejection	$V_{IN} = 7\text{V(Avg)}$ , $V_{\text{RIPPLE}} = 0.5\text{V}_{\text{P-P}}$ , $f_{\text{RIPPLE}} = 120\text{Hz}$ , $I_{LOAD} = 200\text{mA}$	65	75		dB
Current Limit	$V_{IN} = 7\text{V}$ , $V_{OUT} = 0\text{V}$ $V_{IN} = 4.75\text{V}$ , $\Delta V_{OUT} = -0.1\text{V}$ (Note 2)	●	200	400	mA mA
Reverse Output Current (Note 9)	$V_{OUT} = 1.24\text{V}$ , $V_{IN} < 1.24\text{V}$ (Note 2)		12	25	$\mu\text{A}$

**Note 1:** Stresses beyond those listed under Absolute Maximum Ratings may cause permanent damage to the device. Exposure to any Absolute Maximum Rating condition for extended periods may affect device reliability and lifetime.

**Note 2:** The LT3012 is tested and specified for these conditions with the ADJ pin connected to the OUT pin.

**Note 3:** Operating conditions are limited by maximum junction temperature. The regulated output voltage specification will not apply for all possible combinations of input voltage and output current. When operating at maximum input voltage, the output current range must be limited. When operating at maximum output current, the input voltage range must be limited.

**Note 4:** To satisfy requirements for minimum input voltage, the LT3012 is tested and specified for these conditions with an external resistor divider (249k bottom, 649k top) for an output voltage of 4.5V. The external resistor divider will add a  $5\mu\text{A}$  DC load on the output.

**Note 5:** Dropout voltage is the minimum input to output voltage differential needed to maintain regulation at a specified output current. In dropout, the output voltage will be equal to  $(V_{IN} - V_{\text{DROPOUT}})$ .

**Note 6:** GND pin current is tested with  $V_{IN} = 4.75\text{V}$  and a current source load. This means the device is tested while operating close to its dropout region. This is the worst-case GND pin current. The GND pin current will decrease slightly at higher input voltages.

**Note 7:** ADJ pin bias current flows into the ADJ pin.

**Note 8:**  $\overline{\text{SHDN}}$  pin current flows out of the  $\overline{\text{SHDN}}$  pin.

**Note 9:** Reverse output current is tested with the IN pin grounded and the OUT pin forced to the rated output voltage. This current flows into the OUT pin and out the GND pin.

**Note 10:** The LT3012E is guaranteed to meet performance specifications from  $0^{\circ}\text{C}$  to  $125^{\circ}\text{C}$  operating junction temperature. Specifications over the  $-40^{\circ}\text{C}$  to  $125^{\circ}\text{C}$  operating junction temperature range are assured by design, characterization and correlation with statistical process controls. The LT3012H is tested to the LT3012H Electrical Characteristics table at  $140^{\circ}\text{C}$  operating junction temperature. High junction temperatures degrade operating lifetimes. Operating lifetime is derated at junction temperatures greater than  $125^{\circ}\text{C}$ .

**Note 11:** This IC includes overtemperature protection that is intended to protect the device during momentary overload conditions. Junction temperature will exceed  $125^{\circ}\text{C}$  (LT3012E) or  $140^{\circ}\text{C}$  (LT3012H) when overtemperature protection is active. Continuous operation above the specified maximum operating junction temperature may impair device reliability.

# TYPICAL PERFORMANCE CHARACTERISTICS

**Typical Dropout Voltage**

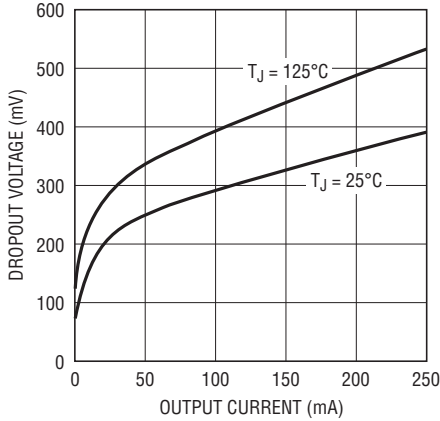

3012 G01

**Guaranteed Dropout Voltage**

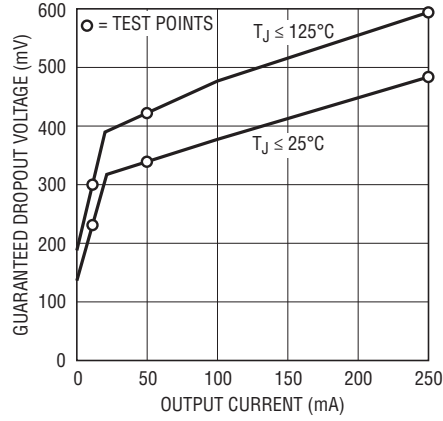

3012 G02

**Dropout Voltage**

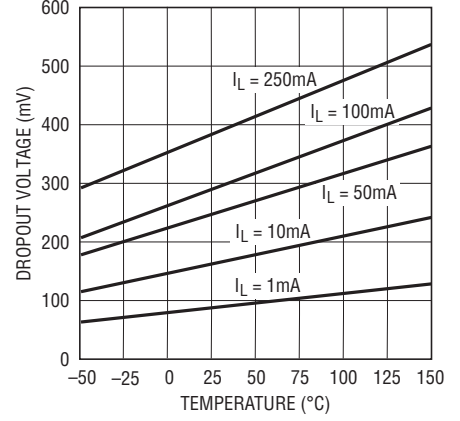

3012 G03

**Quiescent Current**

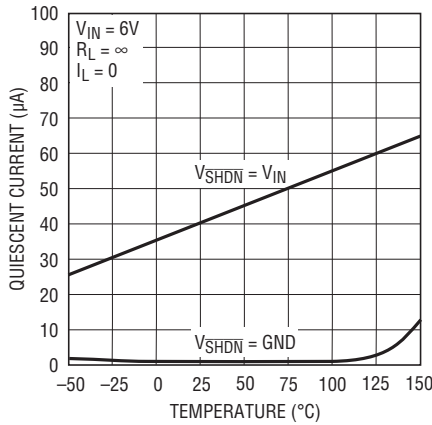

3012 G04

**ADJ Pin Voltage**

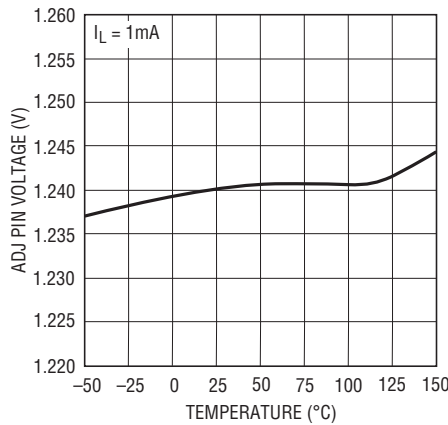

3012 G05

**Quiescent Current**

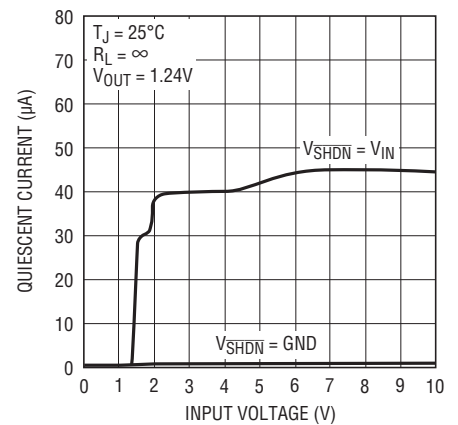

3012 G06

**Quiescent Current**

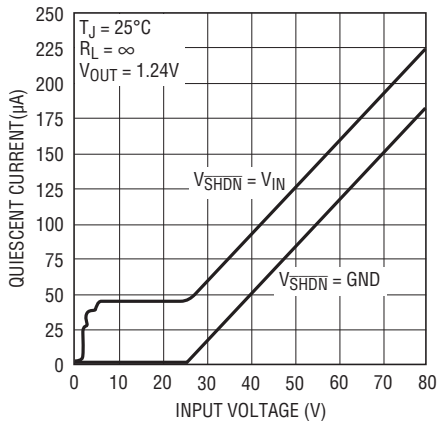

3012 G07

**GND Pin Current**

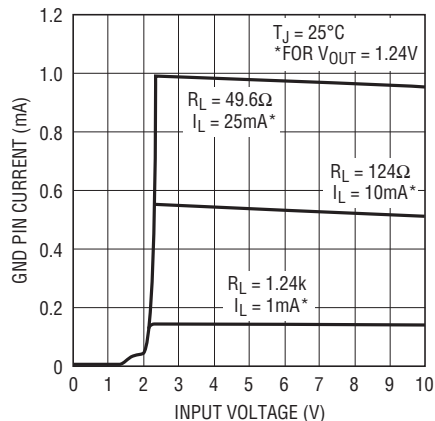

3012 G08

**GND Pin Current**

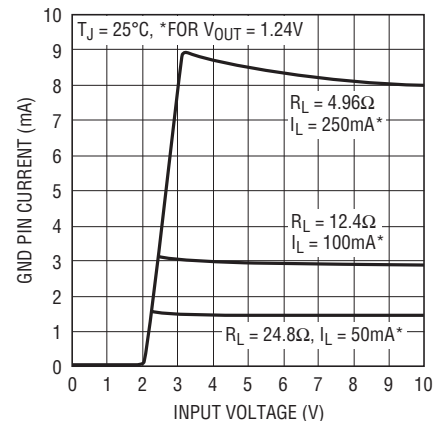

3012 G09

## TYPICAL PERFORMANCE CHARACTERISTICS

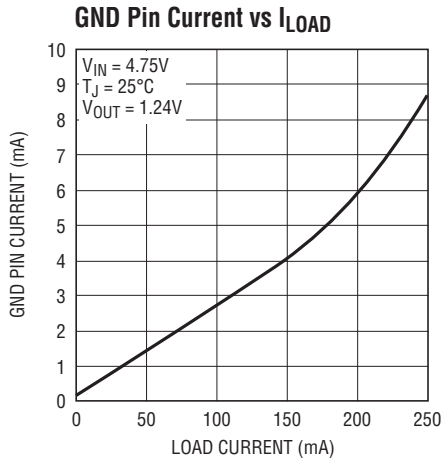

3012 G10

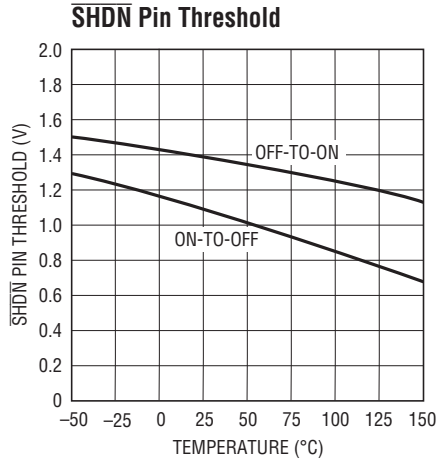

3012 G11

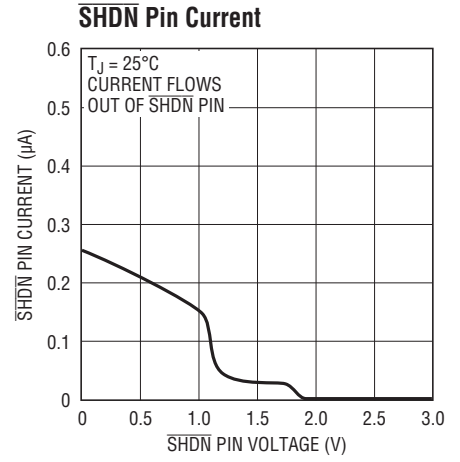

3012 G12

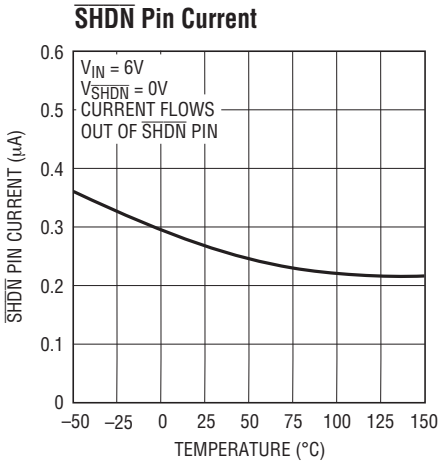

3012 G13

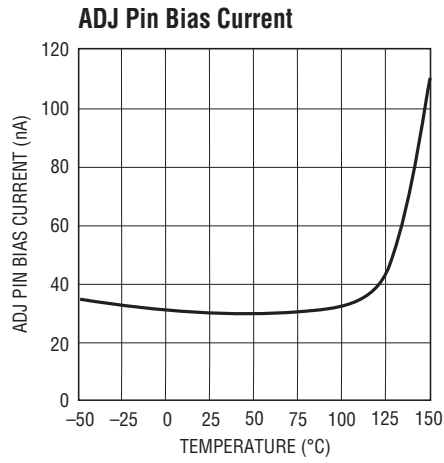

3012 G14

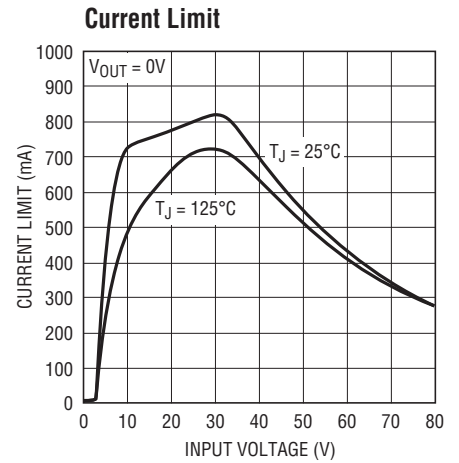

3012 G15

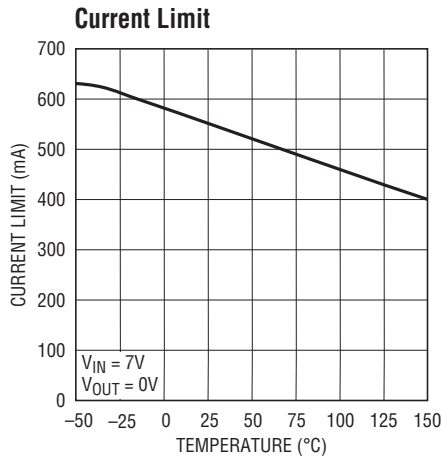

3012 G16

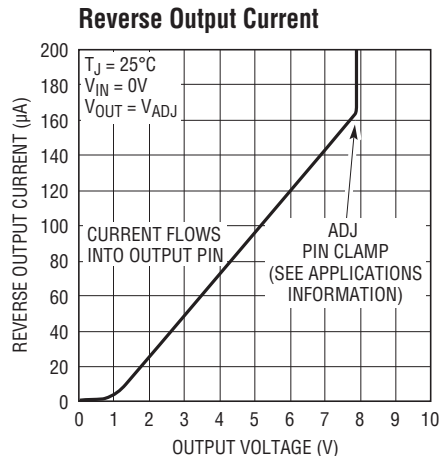

3012 G17

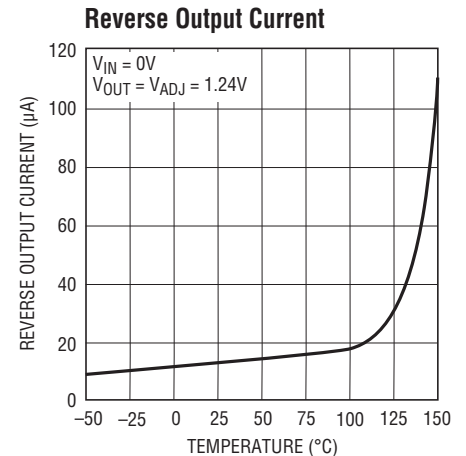

3012 G18

# TYPICAL PERFORMANCE CHARACTERISTICS

**Input Ripple Rejection**

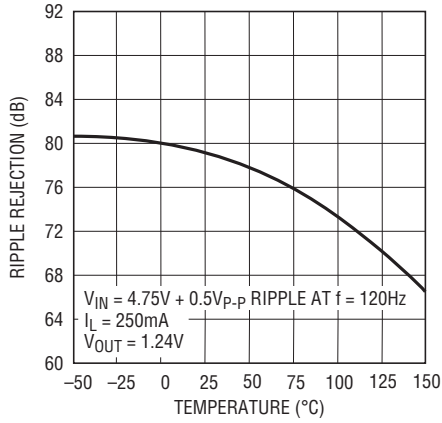

**Input Ripple Rejection**

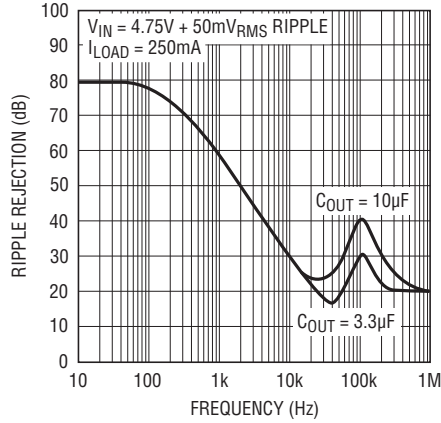

**Minimum Input Voltage**

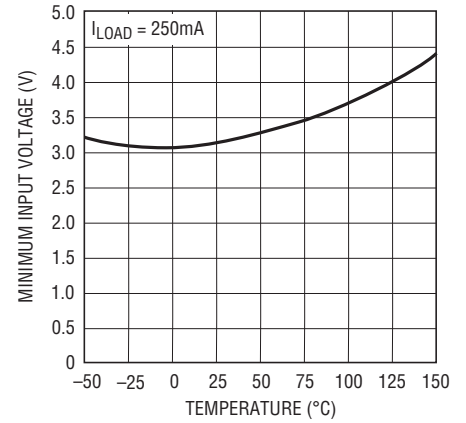

**Load Regulation**

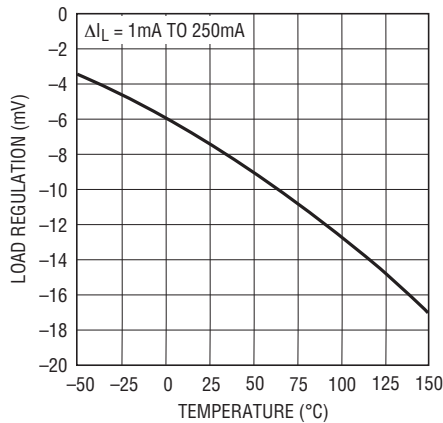

**Output Noise Spectral Density**

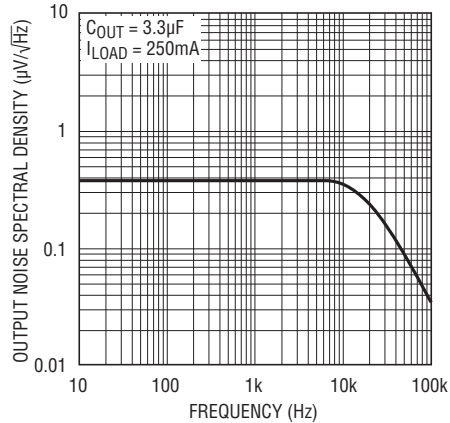

**10Hz to 100kHz Output Noise**

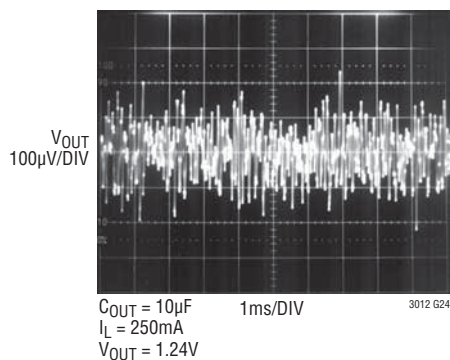

**Transient Response**

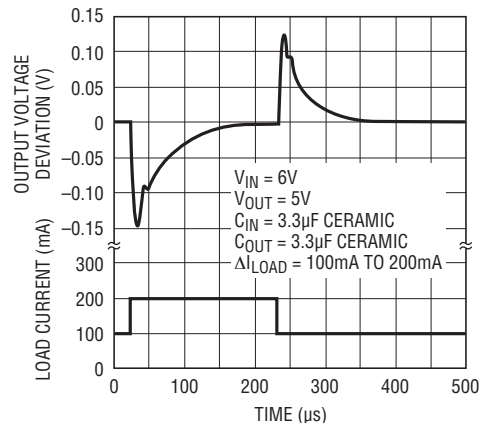

## PIN FUNCTIONS (DFN Package/TSSOP Package)

**NC (Pins 1, 6, 7, 9, 12)/(Pins 2, 7, 10, 12, 15):** No Connect. These pins have no internal connection; connecting NC pins to a copper area for heat dissipation provides a small improvement in thermal performance.

**OUT (Pins 2, 3)/(Pins 3, 4):** Output. The output supplies power to the load. A minimum output capacitor of 3.3 $\mu$ F is required to prevent oscillations. Larger output capacitors will be required for applications with large transient loads to limit peak voltage transients. See the Applications Information section for more information on output capacitance and reverse output characteristics.

**ADJ (Pin 4)/(Pin 5):** Adjust. This is the input to the error amplifier. This pin is internally clamped to  $\pm 7V$ . It has a bias current of 30nA which flows into the pin (see curve of ADJ Pin Bias Current vs Temperature in the Typical Performance Characteristics). The ADJ pin voltage is 1.24V referenced to ground, and the output voltage range is 1.24V to 60V.

**GND (Pins 5, 13)/(Pins 1, 6, 8, 9, 16, 17):** Ground. The exposed backside of the package is an electrical connection for GND. As such, to ensure optimum device operation and thermal performance, the exposed pad must be connected directly to pin 5/pin 6 on the PC board.

**$\overline{\text{SHDN}}$  (Pin 8)/(Pin 11):** Shutdown. The  $\overline{\text{SHDN}}$  pin is used to put the LT3012 into a low power shutdown state. The output will be off when the  $\overline{\text{SHDN}}$  pin is pulled low. The  $\overline{\text{SHDN}}$  pin can be driven either by 5V logic or open-collector logic with a pull-up resistor. The pull-up resistor is only required to supply the pull-up current of the open-collector gate, normally several microamperes. If unused, the  $\overline{\text{SHDN}}$  pin must be tied to a logic high or to  $V_{\text{IN}}$ .

**IN (Pins 10, 11)/(Pins 13, 14):** Input. Power is supplied to the device through the IN pin. A bypass capacitor is required on this pin if the device is more than six inches away from the main input filter capacitor. In general, the output impedance of a battery rises with frequency, so it is advisable to include a bypass capacitor in battery-powered circuits. A bypass capacitor in the range of 1 $\mu$ F to 10 $\mu$ F is sufficient. The LT3012 is designed to withstand reverse voltages on the IN pin with respect to ground and the OUT pin. In the case of a reversed input, which can happen if a battery is plugged in backwards, the LT3012 will act as if there is a diode in series with its input. There will be no reverse current flow into the LT3012 and no reverse voltage will appear at the load. The device will protect both itself and the load.

## APPLICATIONS INFORMATION

The LT3012 is a 250mA high voltage low dropout regulator with micropower quiescent current and shutdown. The device is capable of supplying 250mA at a dropout voltage of 400mV. The low operating quiescent current (40 $\mu$ A) drops to 1 $\mu$ A in shutdown. In addition to the low quiescent current, the LT3012 incorporates several protection features which make it ideal for use in battery-powered systems. The device is protected against both reverse input and reverse output voltages. In battery backup applications where the output can be held up by a backup battery when the input is pulled to ground, the LT3012 acts like it has a diode in series with its output and prevents reverse current flow.

### Adjustable Operation

The LT3012 has an output voltage range of 1.24V to 60V. The output voltage is set by the ratio of two external resistors as shown in Figure 1. The device servos the output to maintain the voltage at the adjust pin at 1.24V referenced to ground. The current in R1 is then equal to  $1.24V/R1$  and the current in R2 is the current in R1 plus the ADJ pin bias current. The ADJ pin bias current, 30nA at 25°C, flows through R2 into the ADJ pin. The output voltage can be calculated using the formula in Figure 1. The value of R1 should be less than 250k to minimize errors in the output voltage caused by the ADJ pin bias current. Note that in shutdown the output is turned off and the divider current will be zero.



## APPLICATIONS INFORMATION

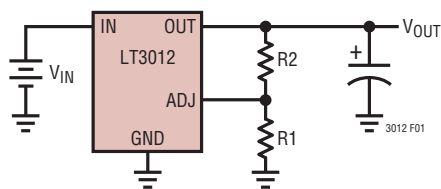

$$V_{OUT} = 1.24V \left( 1 + \frac{R_2}{R_1} \right) + (I_{ADJ})(R_2)$$

$$V_{ADJ} = 1.24V$$

$$I_{ADJ} = 30nA \text{ AT } 25^\circ C$$

$$\text{OUTPUT RANGE} = 1.24V \text{ TO } 60V$$

Figure 1. Adjustable Operation

The adjustable device is tested and specified with the ADJ pin tied to the OUT pin and a 5µA DC load (unless otherwise specified) for an output voltage of 1.24V. Specifications for output voltages greater than 1.24V will be proportional to the ratio of the desired output voltage to 1.24V; ( $V_{OUT}/1.24V$ ). For example, load regulation for an output current change of 1mA to 250mA is -7mV typical at  $V_{OUT} = 1.24V$ . At  $V_{OUT} = 12V$ , load regulation is:

$$(12V/1.24V) \cdot (-7mV) = -68mV$$

### Output Capacitance and Transient Response

The LT3012 is designed to be stable with a wide range of output capacitors. The ESR of the output capacitor affects stability, most notably with small capacitors. A minimum output capacitor of 3.3µF with an ESR of 3Ω or less is recommended to prevent oscillations. The LT3012 is a micropower device and output transient response will be a function of output capacitance. Larger values of output capacitance decrease the peak deviations and provide

improved transient response for larger load current changes. Bypass capacitors, used to decouple individual components powered by the LT3012, will increase the effective output capacitor value.

Extra consideration must be given to the use of ceramic capacitors. Ceramic capacitors are manufactured with a variety of dielectrics, each with different behavior across temperature and applied voltage. The most common dielectrics used are specified with EIA temperature characteristic codes of Z5U, Y5V, X5R and X7R. The Z5U and Y5V dielectrics are good for providing high capacitances in a small package, but they tend to have strong voltage and temperature coefficients as shown in Figures 2 and 3. When used with a 5V regulator, a 16V 10µF Y5V capacitor can exhibit an effective value as low as 1µF to 2µF for the DC bias voltage applied and over the operating temperature range. The X5R and X7R dielectrics result in more stable characteristics and are more suitable for use as the output capacitor. The X7R type has better stability across temperature, while the X5R is less expensive and is available in higher values. Care still must be exercised when using X5R and X7R capacitors; the X5R and X7R codes only specify operating temperature range and maximum capacitance change over temperature. Capacitance change due to DC bias with X5R and X7R capacitors is better than Y5V and Z5U capacitors, but can still be significant enough to drop capacitor values below appropriate levels. Capacitor DC bias characteristics tend to improve as component case size increases, but expected capacitance at operating voltage should be verified.

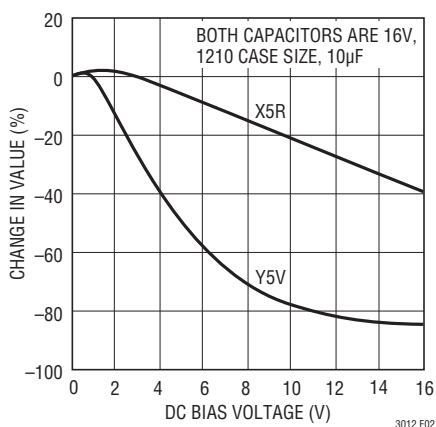

Figure 2. Ceramic Capacitor DC Bias Characteristics

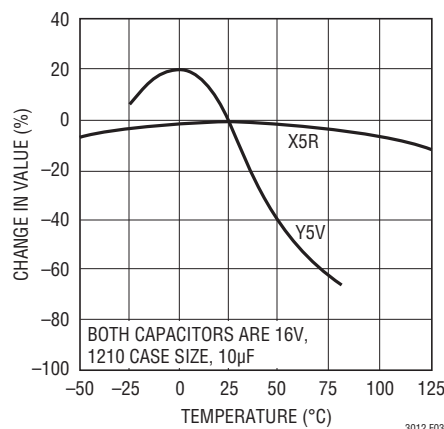

Figure 3. Ceramic Capacitor Temperature Characteristics

## APPLICATIONS INFORMATION

Voltage and temperature coefficients are not the only sources of problems. Some ceramic capacitors have a piezoelectric response. A piezoelectric device generates voltage across its terminals due to mechanical stress, similar to the way a piezoelectric accelerometer or microphone works. For a ceramic capacitor the stress can be induced by vibrations in the system or thermal transients.

### Current Limit and Safe Operating Area Protection

Like many IC power regulators, the LT3012 has safe operating area protection. The safe operating area protection decreases the current limit as the input voltage increases and keeps the power transistor in a safe operating region. The protection is designed to provide some output current at all values of input voltage up to the device breakdown (see curve of Current Limit vs Input Voltage in the Typical Performance Characteristics).

The LT3012 is limited for operating conditions by maximum junction temperature. While operating at maximum input voltage, the output current range must be limited; when operating at maximum output current, the input voltage range must be limited. Device specifications will not apply for all possible combinations of input voltage and output current. Operating the LT3012 beyond the maximum junction temperature rating may impair the life of the device.

### Thermal Considerations

The power handling capability of the device will be limited by the maximum rated junction temperature of (125°C for LT3012E, or 140°C for LT3012HFE). The power dissipated by the device will be made up of two components:

1. Output current multiplied by the input/output voltage differential:  $I_{OUT} \cdot (V_{IN} - V_{OUT})$  and,
2. GND pin current multiplied by the input voltage:  $I_{GND} \cdot V_{IN}$ .

The GND pin current can be found by examining the GND Pin Current curves in the Typical Performance Characteristics. Power dissipation will be equal to the sum of the two components listed above.

The LT3012 has internal thermal limiting designed to protect the device during overload conditions. For continuous

normal conditions the maximum junction temperature rating of 125°C (E-Grade) or 140°C (H-Grade) must not be exceeded. It is important to give careful consideration to all sources of thermal resistance from junction to ambient. Additional heat sources mounted nearby must also be considered.

For surface mount devices, heat sinking is accomplished by using the heat spreading capabilities of the PC board and its copper traces. Copper board stiffeners and plated through-holes can also be used to spread the heat generated by power devices.

The following tables list thermal resistance for several different board sizes and copper areas. All measurements were taken in still air on 3/32" FR-4 board with one ounce copper.

**Table 1. DFN Measured Thermal Resistance**

COPPER AREA TOPSIDE	BOARD AREA	THERMAL RESISTANCE (JUNCTION-TO-AMBIENT)
2500 sq mm	2500 sq mm	40°C/W
1000 sq mm	2500 sq mm	45°C/W
225 sq mm	2500 sq mm	50°C/W
100 sq mm	2500 sq mm	62°C/W

**Table 2. TSSOP Measured Thermal Resistance**

COPPER AREA TOPSIDE	BOARD AREA	THERMAL RESISTANCE (JUNCTION-TO-AMBIENT)
2500 sq mm	2500 sq mm	40°C/W
1000 sq mm	2500 sq mm	45°C/W
225 sq mm	2500 sq mm	50°C/W
100 sq mm	2500 sq mm	62°C/W

The thermal resistance junction-to-case ( $\theta_{JC}$ ), measured at the exposed pad on the back of the die, is 16°C/W.

Continuous operation at large input/output voltage differentials and maximum load current is not practical due to thermal limitations. Transient operation at high input/output differentials is possible. The approximate thermal time constant for a 2500sq mm 3/32" FR-4 board with maximum topside and backside area for one ounce copper is 3 seconds. This time constant will increase as more thermal mass is added (i.e., vias, larger board, and other components).

## APPLICATIONS INFORMATION

For an application with transient high power peaks, average power dissipation can be used for junction temperature calculations as long as the pulse period is significantly less than the thermal time constant of the device and board.

### Calculating Junction Temperature

Example 1: Given an output voltage of 5V, an input voltage range of 24V to 30V, an output current range of 0mA to 50mA, and a maximum ambient temperature of 50°C, what will the maximum junction temperature be?

The power dissipated by the device will be equal to:

$$I_{OUT(MAX)} \cdot (V_{IN(MAX)} - V_{OUT}) + (I_{GND} \cdot V_{IN(MAX)})$$

where:

$$I_{OUT(MAX)} = 50\text{mA}$$

$$V_{IN(MAX)} = 30\text{V}$$

$$I_{GND} \text{ at } (I_{OUT} = 50\text{mA}, V_{IN} = 30\text{V}) = 1\text{mA}$$

So:

$$P = 50\text{mA} \cdot (30\text{V} - 5\text{V}) + (1\text{mA} \cdot 30\text{V}) = 1.28\text{W}$$

The thermal resistance will be in the range of 40°C/W to 62°C/W depending on the copper area. So the junction temperature rise above ambient will be approximately equal to:

$$1.31\text{W} \cdot 50^\circ\text{C/W} = 65.5^\circ\text{C}$$

The maximum junction temperature will then be equal to the maximum junction temperature rise above ambient plus the maximum ambient temperature or:

$$T_{JMAX} = 50^\circ\text{C} + 65.5^\circ\text{C} = 115.5^\circ\text{C}$$

Example 2: Given an output voltage of 5V, an input voltage of 48V that rises to 72V for 5ms(max) out of every 100ms, and a 5mA load that steps to 50mA for 50ms out of every 250ms, what is the junction temperature rise above ambient? Using a 500ms period (well under the time constant of the board), power dissipation is as follows:

$$P1(48\text{V in, 5mA load}) = 5\text{mA} \cdot (48\text{V} - 5\text{V}) \\ + (200\mu\text{A} \cdot 48\text{V}) = 0.23\text{W}$$

$$P2(48\text{V in, 50mA load}) = 50\text{mA} \cdot (48\text{V} - 5\text{V}) \\ + (1\text{mA} \cdot 48\text{V}) = 2.20\text{W}$$

$$P3(72\text{V in, 5mA load}) = 5\text{mA} \cdot (72\text{V} - 5\text{V}) \\ + (200\mu\text{A} \cdot 72\text{V}) = 0.35\text{W}$$

$$P4(72\text{V in, 50mA load}) = 50\text{mA} \cdot (72\text{V} - 5\text{V}) \\ + (1\text{mA} \cdot 72\text{V}) = 3.42\text{W}$$

Operation at the different power levels is as follows:

76% operation at P1, 19% for P2, 4% for P3, and 1% for P4.

$$P_{EFF} = 76\%(0.23\text{W}) + 19\%(2.20\text{W}) + 4\%(0.35\text{W}) \\ + 1\%(3.42\text{W}) = 0.64\text{W}$$

With a thermal resistance in the range of 40°C/W to 62°C/W, this translates to a junction temperature rise above ambient of 26°C to 38°C.

### High Temperature Operation

Care must be taken when designing LT3012 applications to operate at high ambient temperatures. The LT3012 works at elevated temperatures but erratic operation can occur due to unforeseen variations in external components. Some tantalum capacitors are available for high temperature operation, but ESR is often several ohms; capacitor ESR above 3Ω is unsuitable for use with the LT3012. Ceramic capacitor manufacturers (Murata, AVX, TDK, and Vishay Vitramon at this writing) now offer ceramic capacitors that are rated to 150°C using an X8R dielectric. Device instability will occur if output capacitor value and ESR are outside design limits at elevated temperature and operating DC voltage bias (see information on capacitor characteristics under Output Capacitance and Transient Response). Check each passive component for absolute value and voltage ratings over the operating temperature range.

**Leakages in capacitors or from solder flux left after insufficient board cleaning adversely affects low quiescent current operation.** The output voltage resistor divider should use a maximum bottom resistor value of 124k to compensate for high temperature leakage, setting divider current to 10μA. Consider junction temperature increase due to power dissipation in both the junction and nearby components to ensure maximum specifications are not violated for the device or external components.

## APPLICATIONS INFORMATION

### Protection Features

The LT3012 incorporates several protection features which make it ideal for use in battery-powered circuits. In addition to the normal protection features associated with monolithic regulators, such as current limiting and thermal limiting, the device is protected against reverse-input voltages, and reverse voltages from output to input.

Like many IC power regulators, the LT3012 has safe operating area protection. The safe area protection decreases the current limit as input voltage increases and keeps the power transistor inside a safe operating region for all values of input voltage. The protection is designed to provide some output current at all values of input voltage up to the device breakdown. The SOA protection circuitry for the LT3012 uses a current generated when the input voltage exceeds 25V to decrease current limit. This current shows up as additional quiescent current for input voltages above 25V. This increase in quiescent current occurs both in normal operation and in shutdown (see curve of Quiescent Current in the Typical Performance Characteristics).

Current limit protection and thermal overload protection are intended to protect the device against current overload conditions at the output of the device. For normal operation, the junction temperature should not exceed 125°C (LT3012E) or 140°C (LT3012HFE).

The input of the device will withstand reverse voltages of 80V. No negative voltage will appear at the output. The device will protect both itself and the load. This provides protection against batteries which can be plugged in backward.

The ADJ pin of the device can be pulled above or below ground by as much as 7V without damaging the device. If the input is left open circuit or grounded, the ADJ pin will act like an open circuit when pulled below ground, and like a large resistor (typically 100k) in series with a diode when pulled above ground. If the input is powered by a voltage source, pulling the ADJ pin below the reference voltage will cause the device to current limit. This will cause the output to go to a unregulated high voltage. Pulling the ADJ pin above the reference voltage will turn off all output current.

In situations where the ADJ pin is connected to a resistor divider that would pull the ADJ pin above its 7V clamp voltage if the output is pulled high, the ADJ pin input current must be limited to less than 5mA. For example, a resistor divider is used to provide a regulated 1.5V output from the 1.24V reference when the output is forced to 60V. The top resistor of the resistor divider must be chosen to limit the current into the ADJ pin to less than 5mA when the ADJ pin is at 7V. The 53V difference between the OUT and ADJ pins divided by the 5mA maximum current into the ADJ pin yields a minimum top resistor value of 10.6k.

In circuits where a backup battery is required, several different input/output conditions can occur. The output voltage may be held up while the input is either pulled to ground, pulled to some intermediate voltage, or is left open circuit. Current flow back into the output will follow the curve shown in Figure 4. The rise in reverse output current above 7V occurs from the breakdown of the 7V clamp on the ADJ pin. With a resistor divider on the regulator output, this current will be reduced depending on the size of the resistor divider.

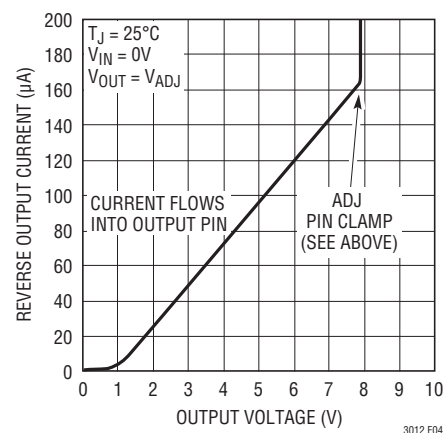
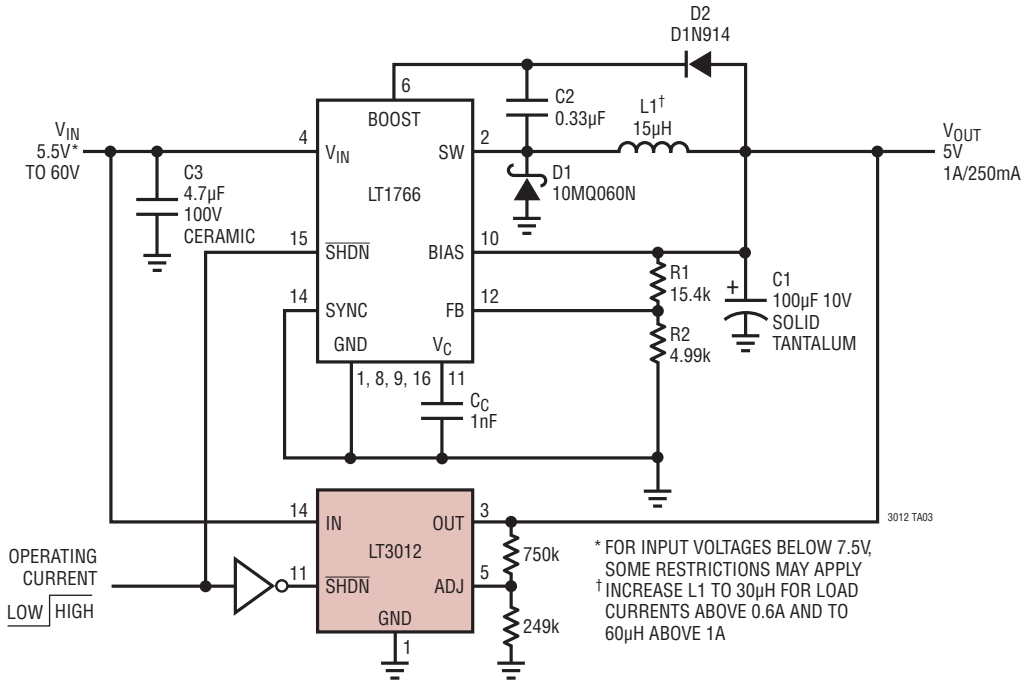

Figure 4. Reverse Output Current

When the IN pin of the LT3012 is forced below the OUT pin or the OUT pin is pulled above the IN pin, input current will typically drop to less than 2µA. This can happen if the input of the LT3012 is connected to a discharged (low voltage) battery and the output is held up by either a backup battery or a second regulator circuit. The state of the SHDN pin will have no effect on the reverse output current when the output is pulled above the input.

TYPICAL APPLICATIONS

5V Buck Converter with Low Current Keep Alive Backup



Buck Converter Efficiency vs Load Current

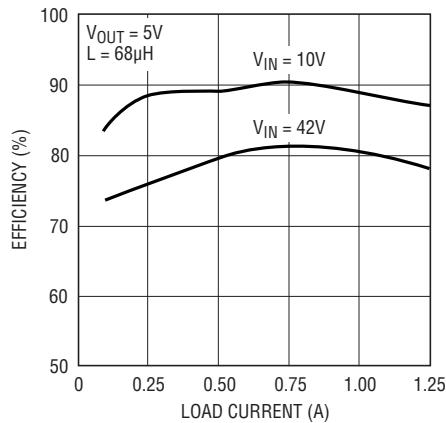

## TYPICAL APPLICATIONS

### LT3012 Automotive Application

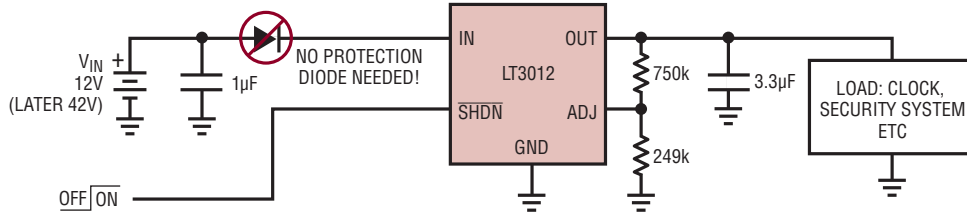

### LT3012 Telecom Application

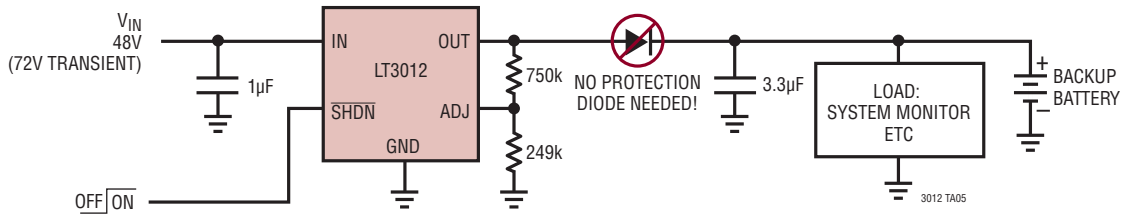

### Constant Brightness for Indicator LED over Wide Input Voltage Range

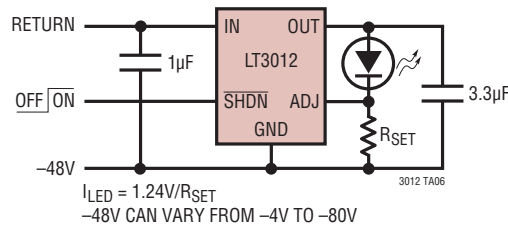

# PACKAGE DESCRIPTION

## DE Package 12-Lead Plastic DFN (4mm × 3mm) (Reference LTC DWG # 05-08-1695)

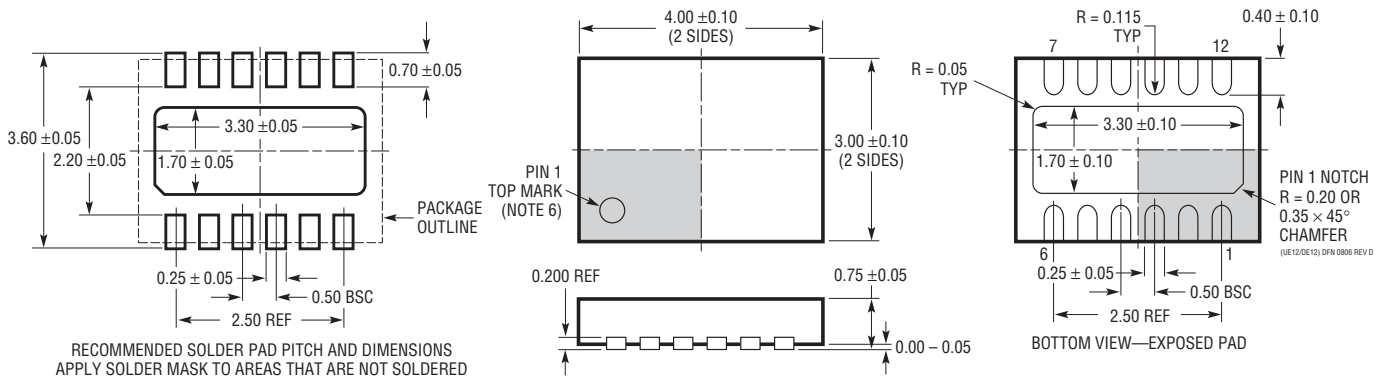

- NOTE:
1. DRAWING PROPOSED TO BE A VARIATION OF VERSION (WGED) IN JEDEC PACKAGE OUTLINE MO-229
  2. DRAWING NOT TO SCALE
  3. ALL DIMENSIONS ARE IN MILLIMETERS
  4. DIMENSIONS OF EXPOSED PAD ON BOTTOM OF PACKAGE DO NOT INCLUDE MOLD FLASH. MOLD FLASH, IF PRESENT, SHALL NOT EXCEED 0.15mm ON ANY SIDE
  5. EXPOSED PAD SHALL BE SOLDER PLATED
  6. SHADED AREA IS ONLY A REFERENCE FOR PIN 1 LOCATION ON THE TOP AND BOTTOM OF PACKAGE

## FE Package 16-Lead Plastic TSSOP (4.4mm) (Reference LTC DWG # 05-08-1663)

### Exposed Pad Variation BB

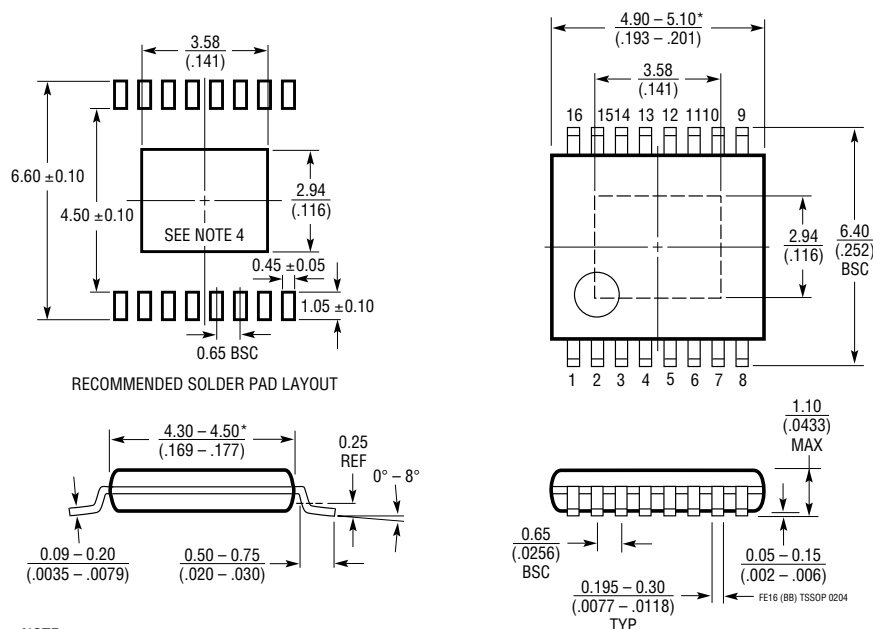

- NOTE:
1. CONTROLLING DIMENSION: MILLIMETERS
  2. DIMENSIONS ARE IN MILLIMETERS (INCHES)
  3. DRAWING NOT TO SCALE
  4. RECOMMENDED MINIMUM PCB METAL SIZE FOR EXPOSED PAD ATTACHMENT
- \*DIMENSIONS DO NOT INCLUDE MOLD FLASH. MOLD FLASH SHALL NOT EXCEED 0.150mm (.006") PER SIDE

## RELATED PARTS

PART NUMBER	DESCRIPTION	COMMENTS
LT1020	125mA, Micropower Regulator and Comparator	$V_{IN}$ : 4.5V to 36V, $V_{OUT(MIN)}$ = 2.5V, $V_{DO}$ = 0.4V, $I_Q$ = 40 $\mu$ A, $I_{SD}$ = 40 $\mu$ A, Comparator and Reference, Class B Outputs, S16, PDIP14 Packages
LT1120/LT1120A	125mA, Micropower Regulator and Comparator	$V_{IN}$ : 4.5V to 36V, $V_{OUT(MIN)}$ = 2.5V, $V_{DO}$ = 0.4V, $I_Q$ = 40 $\mu$ A, $I_{SD}$ = 10 $\mu$ A, Comparator and Reference, Logic Shutdown, Ref Sources and Sinks 2/4mA, S8, N8 Packages
LT1121/LT1121HV	150mA, Micropower, LDO	$V_{IN}$ : 4.2V to 30/36V, $V_{OUT(MIN)}$ = 3.75V, $V_{DO}$ = 0.42V, $I_Q$ = 30 $\mu$ A, $I_{SD}$ = 16 $\mu$ A, Reverse Battery Protection, SOT-223, S8, Z Packages
LT1129	700mA, Micropower, LDO	$V_{IN}$ : 4.2V to 30V, $V_{OUT(MIN)}$ = 3.75V, $V_{DO}$ = 0.4V, $I_Q$ = 50 $\mu$ A, $I_{SD}$ = 16 $\mu$ A, DD, SOT-223, S8, TO220-5, TSSOP20 Packages
LT1676	60V, 440mA ( $I_{OUT}$ ), 100kHz, High Efficiency Step-Down DC/DC Converter	$V_{IN}$ : 7.4V to 60V, $V_{OUT(MIN)}$ = 1.24V, $I_Q$ = 3.2mA, $I_{SD}$ = 2.5 $\mu$ A, S8 Package
LT1761	100mA, Low Noise Micropower, LDO	$V_{IN}$ : 1.8V to 20V, $V_{OUT(MIN)}$ = 1.22V, $V_{DO}$ = 0.3V, $I_Q$ = 20 $\mu$ A, $I_{SD}$ = <1 $\mu$ A, Low Noise < 20 $\mu$ V <sub>RMS</sub> , Stable with 1 $\mu$ F Ceramic Capacitors, ThinSOT™ Package
LT1762	150mA, Low Noise Micropower, LDO	$V_{IN}$ : 1.8V to 20V, $V_{OUT(MIN)}$ = 1.22V, $V_{DO}$ = 0.3V, $I_Q$ = 25 $\mu$ A, $I_{SD}$ = <1 $\mu$ A, Low Noise < 20 $\mu$ V <sub>RMS</sub> , MS8 Package
LT1763	500mA, Low Noise Micropower, LDO	$V_{IN}$ : 1.8V to 20V, $V_{OUT(MIN)}$ = 1.22V, $V_{DO}$ = 0.3V, $I_Q$ = 30 $\mu$ A, $I_{SD}$ = <1 $\mu$ A, Low Noise < 20 $\mu$ V <sub>RMS</sub> , S8 Package
LT1764/LT1764A	3A, Low Noise, Fast Transient Response, LDO	$V_{IN}$ : 2.7V to 20V, $V_{OUT(MIN)}$ = 1.21V, $V_{DO}$ = 0.34V, $I_Q$ = 1mA, $I_{SD}$ = <1 $\mu$ A, Low Noise < 40 $\mu$ V <sub>RMS</sub> , "A" Version Stable with Ceramic Capacitors, DD, TO220-5 Packages
LT1766	60V, 1.2A ( $I_{OUT}$ ), 200kHz, High Efficiency Step-Down DC/DC Converter	$V_{IN}$ : 5.5V to 60V, $V_{OUT(MIN)}$ = 1.2V, $I_Q$ = 2.5mA, $I_{SD}$ = 25 $\mu$ A, TSSOP16/E Package
LT1776	40V, 550mA ( $I_{OUT}$ ), 200kHz, High Efficiency Step-Down DC/DC Converter	$V_{IN}$ : 7.4V to 40V, $V_{OUT(MIN)}$ = 1.24V, $I_Q$ = 3.2mA, $I_{SD}$ = 30 $\mu$ A, N8, S8 Packages
LT1934/LT1934-1	300mA/60mA, ( $I_{OUT}$ ), Constant Off-Time, High Efficiency Step-Down DC/DC Converter	90% Efficiency, $V_{IN}$ : 3.2V to 34V, $V_{OUT(MIN)}$ = 1.25V, $I_Q$ = 14 $\mu$ A, $I_{SD}$ = <1 $\mu$ A, ThinSOT Package
LT1956	60V, 1.2A ( $I_{OUT}$ ), 500kHz, High Efficiency Step-Down DC/DC Converter	$V_{IN}$ : 5.5V to 60V, $V_{OUT(MIN)}$ = 1.2V, $I_Q$ = 2.5mA, $I_{SD}$ = 25 $\mu$ A, TSSOP16/E Package
LT1962	300mA, Low Noise Micropower, LDO	$V_{IN}$ : 1.8V to 20V, $V_{OUT(MIN)}$ = 1.22V, $V_{DO}$ = 0.27V, $I_Q$ = 30 $\mu$ A, $I_{SD}$ = <1 $\mu$ A, Low Noise < 20 $\mu$ V <sub>RMS</sub> , MS8 Package
LT1963/LT1963A	1.5A, Low Noise, Fast Transient Response, LDO	$V_{IN}$ : 2.1V to 20V, $V_{OUT(MIN)}$ = 1.21V, $V_{DO}$ = 0.34V, $I_Q$ = 1mA, $I_{SD}$ = <1 $\mu$ A, Low Noise < 40 $\mu$ V <sub>RMS</sub> , "A" Version Stable with Ceramic Capacitors, DD, TO220-5, SOT-223, S8 Packages
LT1964	200mA, Low Noise Micropower, Negative LDO	$V_{IN}$ : -1.9V to -20V, $V_{OUT(MIN)}$ = -1.21V, $V_{DO}$ = 0.34V, $I_Q$ = 30 $\mu$ A, $I_{SD}$ = 3 $\mu$ A, Low Noise < 30 $\mu$ V <sub>RMS</sub> , Stable with Ceramic Capacitors, ThinSOT Package
LT3010/LT3010H	50mA, 3V to 80V, Low Noise Micropower LDO	$V_{IN}$ : 3V to 8V, $V_{OUT(MIN)}$ = 1.275V, $V_{DO}$ = 0.3V, $I_Q$ = 30 $\mu$ A, $I_{SD}$ = 1 $\mu$ A, Low Noise < 100 $\mu$ V <sub>RMS</sub> , MS8E Package, H Grade = +140°C $T_{JMAX}$ .
LT3013/LT3013H	250mA, 4V to 80V, Low Dropout Micropower Linear Regulator with PWRGD	$V_{IN}$ : 4V to 80V, $V_{OUT}$ : 1.24V to 60V, $V_{DO}$ = 0.4V, $I_Q$ = 65 $\mu$ A, $I_{SD}$ = <1 $\mu$ A, Power Good Feature; TSSOP-16E and 4mm x 3mm DFN-12 Packages, H Grade = +140°C $T_{JMAX}$ .
LT3014/HV	20mA, 3V to 80V, Low Dropout Micropower Linear Regulator	$V_{IN}$ : 3V to 80V (100V for 2ms, HV version), $V_{OUT}$ : 1.22V to 60V, $V_{DO}$ = 0.35V, $I_Q$ = 7 $\mu$ A, $I_{SD}$ = <1 $\mu$ A, ThinSOT and 3mm x 3mm DFN-8 Packages.

ThinSOT is a trademark of Linear Technology Corporation.